

DRIVER INFORMATION DISPLAY MANUAL

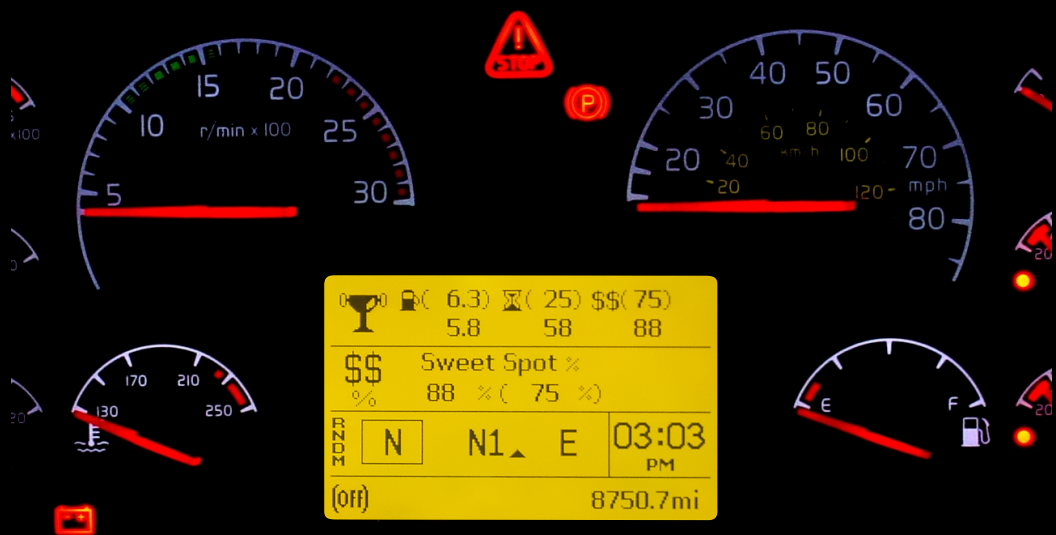

Volvo Trucks. Driving Success.®



Foreword	1
Safety Information	2
Labels	3
Driver Information Display (DID)	3
Stalk Switch Functions	4
Selecting a Menu	4
Changing Settings	5
Basic Level Instrument Cluster DID	5
Basic Menus	6
Digital Gauges	7
Display Settings	7
Time/Date	7
Aftertreatment	8
Setup	9
Mid-Level and High-Level Instrument Cluster DID	10
Mid-Level and High-Level DID Menus	11
Driving Menus	12
Digital Gauges in the DID (High and Mid Level Cluster Only)	13
Fuel Data	18
Time/Distance	23
Aftertreatment	26
Volvo Link	29
Display	29
Vehicle Messages	32
Reset	34
Non-Driving Menu	34
Display Setting	35
Vehicle Settings	41
Diagnostics	45
Vehicle Data	49
Datalog	50
Password	59

Display Symbols	62
Alarm, Check and Information Symbols	62
Status Symbols	69
Other Symbols	70
Messages	71
General	71
Stop Message	71
Warning Message	72
Information Message	73
Stop, Check, Info Symbols and Associated Icons . . .	74
Acknowledging Messages	76
Examples of Fault Symbols and Text	76
Examples of Symbol and Value	78
Index	79

This manual contains information concerning the safe operation of your vehicle. It is extremely important that this information is read and understood before the vehicle is operated. Please keep this manual in the vehicle at all times.

NOTE

It is important that this manual stays with the vehicle when it is sold. Important safety information must be passed on to the new customer.

NOTE

Illustrations in this manual are used for reference only and may differ slightly from the actual vehicle, however, key components addressed in the manual are represented as accurately as possible.

All information, illustrations and specifications contained in this manual are based upon the latest product information available at the time of publication. Volvo Trucks North America reserves the right to make changes at any time or to change specifications or design without notice and without incurring obligation.

The National Highway Traffic Safety Administration (NHTSA) and Volvo Trucks North America should be informed immediately if you believe that the vehicle has a defect that could cause a vehicle accident, injury or death.

Contact NHTSA by calling the Auto Safety Hotline at 1 (888) 327-4236, by writing to NHTSA, U.S. Department of Transportation, Washington, DC 20590, by TTY at 1 (800) 424-9153, or visit their website at www.nhtsa.dot.gov.

Volvo Trucks North America

Greensboro, NC USA

Order number: PV776-21012748

© Volvo Group North America, Inc. 2007. All Rights Reserved.

No part of this publication may be reproduced, stored in retrieval system, or transmitted in any forms by any means, electronic, mechanical, photocopying, recording or otherwise, without the prior written permission of Volvo Trucks North America.

SAFETY INFORMATION

IMPORTANT: Before driving this vehicle, be certain that you have read and that you fully understand each and every step of the driving and handling information in this manual. Be certain that you fully understand and follow all safety warnings. It is extremely important that this information is read and understood before the vehicle is operated.

IT IS IMPORTANT THAT THE FOLLOWING INFORMATION BE READ, UNDERSTOOD AND ALWAYS FOLLOWED.

The following types of advisories are used throughout this manual:

 **DANGER**

A danger directs the operator's attention to unsafe practices which could result in serious personal injury or death. The danger title is in white type on a black background.

 **WARNING**

A warning directs the operator's attention to unsafe practices which could result in personal injury. The warning title is in black type on a gray background.

 **CAUTION**

*A caution directs the operator's attention to unsafe practices where property damage could occur. The caution title is in **black** type on a **white** background.*

 **NOTE**

A note defines an operating procedure, practice, condition, etc., which is essential to proper operation of the vehicle.

Labels

Danger, Warning, Caution and Advisory labels are placed in various locations of the vehicle to alert drivers and service technicians about situations that may lead to personal injury or equipment damage. In the event that a label is damaged or missing the **label must be replaced**. Contact your authorized Volvo Truck dealer for assistance regarding labels.

STALK SWITCH CONTROL LEVER

The stalk switch control lever is used to interact with the DID. The lever is located on the right-hand side of the steering wheel.

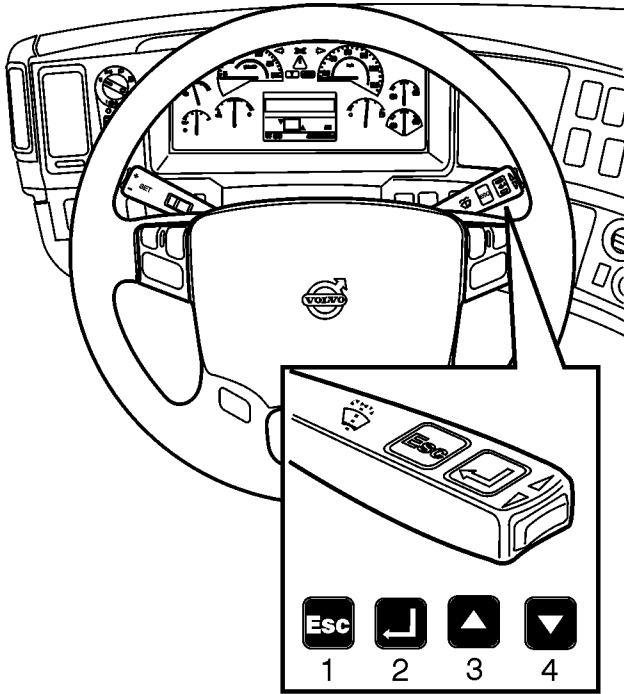

4 Driver Information Display (DID)

Stalk Switch Functions

- The Esc or Escape button is used to return to the previous menu or display, or to cancel a setting or operation.
- The Enter button is used to display a list of menus, open a menu, and select a chosen value.
- The Up arrow is used to scroll up through a menu and to increase numerical values.
- The Down arrow is used to scroll down through a menu and to decrease numerical values.

In key off mode, press Enter to display the time and odometer for 30 seconds.

Selecting a Menu

1. Press the Enter button to display the available menus.
2. Use the up and down arrows to scroll through the list of menus.
3. Press the Enter button to open the selected menu.
4. Press the Esc button to return to the previous menu or display, or to cancel a setting or operation.

Gauges []

Fuel Data

Time / Distance

Aftertreatment

R N D M	N	N1	E	07:49 AM
------------------	---	----	---	-------------

 156.0 mi

Changing Settings

1. The up and down arrows increase and decrease set values.
2. Press the Enter button to confirm the choice and move to the next position.
3. Press the Esc button to return to the previous position, or to cancel a setting or operation.

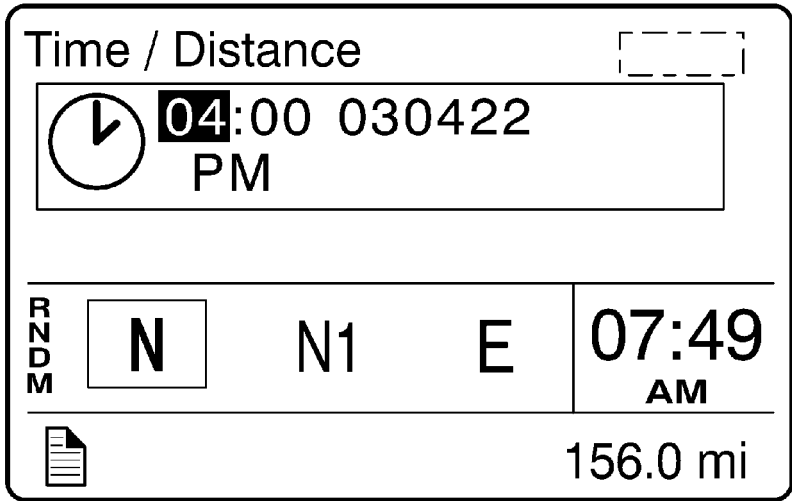

BASIC LEVEL INSTRUMENT CLUSTER DID

The basic Driver Information Display (DID) is located in the center of the basic level instrument cluster. The DID displays digital gauges, main menus and sub-menus that provide necessary and important information to the vehicle operator. The information available to the operator depends on vehicle configuration.

There are two sections of display information in the basic DID:

- Top — Menus and gauges
- Bottom — Odometer

The default display is clock and odometer. Press the Enter button to display the menu.

6 Driver Information Display (DID)



1. Menus and gauges

2. Odometer

Basic Menus

The following menus are available with the basic DID.

- Digital Gauges
 - Outside Temperature
 - Distance to Destination
- Display Settings
 - Contrast
 - Backlight
- Time/Date
- Aftertreatment
 - Initiate REGEN
 - ATS Status
 - Cancel REGEN
- Setup
 - Language
 - Distance
 - Temperature

Digital Gauges

1. Outside Temperature

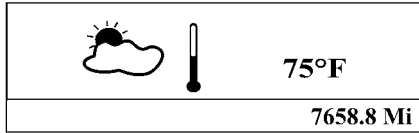

2. Distance to Destination



Display Settings

1. Contrast

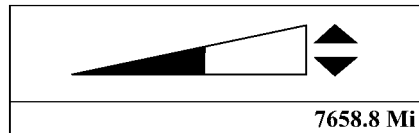

2. Backlight

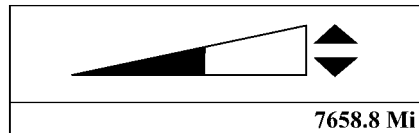

Time/Date

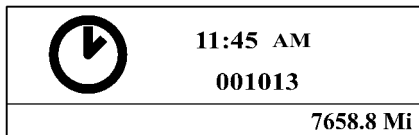

8 Driver Information Display (DID)

Aftertreatment

When ATS Status is selected, the following menus are available. For additional information about the aftertreatment system, refer to the vehicle operator's manual.

Clutch	OK	▲
Service Brake	OK	
PTO Status	OK	▼
<hr/>		
7721.4 mi		

Acc Pedal	OK	▲
Neutral	OK	
Vehicle Speed Above	OK	▼
<hr/>		
7721.4 mi		

Park Brake	OK	▲
System Fault	OK	
System Timeout	OK	▼
<hr/>		
7721.4 mi		

Temporary Lockout	OK	▲
Permanent Lockout	OK	
Engine Temp	OK	▼
<hr/>		
7721.4 mi		

Exhaust Temp	OK	▲
Vehicle Speed Below	OK	
Inhibit Switch	OK	▼
<hr/>		
7721.4 mi		

Setup

1. Language

<input checked="" type="checkbox"/> English <input type="checkbox"/> Espanol <input type="checkbox"/> Francais
7658.8 Mi

2. Distance

<input type="checkbox"/> km <input checked="" type="checkbox"/> Miles
7658.8 Mi

3. Temperature

<input checked="" type="checkbox"/> °C <input type="checkbox"/> °F
7658.8 Mi

10 Driver Information Display (DID)

MID-LEVEL AND HIGH-LEVEL INSTRUMENT CLUSTER DID

The Driver Information Display (DID) is located in the center of the mid-level and high-level instrument clusters. It displays digital gauges, main menus and sub-menus that provide necessary and important information to the vehicle operator.

The information available to the operator depends on vehicle configuration, and whether the vehicle is in operation or parked. Certain functions are password-protected and are not shown until the correct password is entered. See “Password” on page 59.

There are three sections of display information in the DID:

- Top — Messages and available menus
- Middle — Favorite display
- Bottom — Current status and odometer

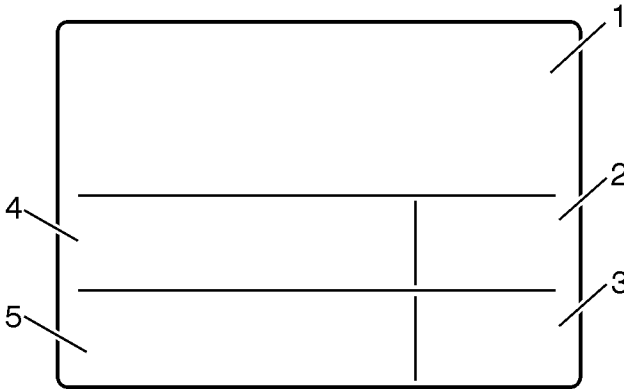

1. Messages and Available Menus 2. Clock 3. Odometer	4. Favorite Display 5. Current Status
--	--

The top section displays messages, selected digital gauges, and the available DID menus. The favorite display, clock, odometer and current status are always visible. The current status section provides status information required at all times.

DID, example screen view:

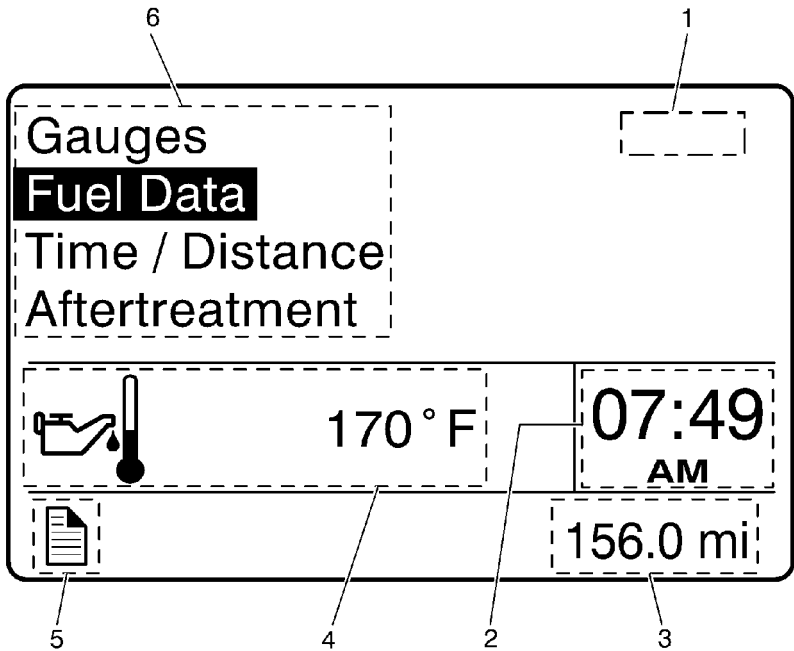

<ol style="list-style-type: none"> 1. Indicates First of Six Available Menus (varies by menu) 2. Clock 3. Odometer 	<ol style="list-style-type: none"> 4. Favorite Display 5. Current Status Icon(s) 6. Messages and Available Menus
---	---

Mid-Level and High-Level DID Menus

There are **Driving** and **Non-Driving** menus. Several sub-menus are password-protected while the vehicle is parked. The Non-Driving menu is accessible **only** when the vehicle is parked.

12 Driver Information Display (DID)

Driving Menus

- Gauges
 - Current Gear Position (Automated Transmission)
 - Outside Temperature
 - Temperature Engine Oil
 - Temperature Transmission
 - Battery Voltage
 - Axle Temperature (Front/Rear)
 - Air Suspension (Front/Rear)
 - Volvo Link Compass
- Fuel Data
 - Instantaneous Gallons per Hour
 - Trip Fuel Used
 - Distance to Empty
 - Fuel Economy
 - Idle Percent
 - Sweet Spot/Performance Bonus
 - Sweet Spot Percentage
 - Road Speed Limit
- Time/Distance
 - Time and Date
 - Alarm Clock
 - Distance to Destination
 - Average Trip Speed
 - Estimated Time of Arrival (ETA)
- Aftertreatment
 - Request Parked REGEN
 - ATS Status
 - Cancel REGEN

- Volvo Link
 - Read Message
 - Send Message
 - Statistics
- Display
 - Black Panel
 - Favorite Display
 - Backlight
 - Favorite Display Setting
 - Night/Day
- Vehicle Messages
- Reset

Digital Gauges in the DID (High and Mid Level Cluster Only)

There are several gauges in the Gauges menu. The number of gauges your vehicle is programmed with depends on the equipment level of the vehicle. The gauges are used to view current status of important functions in the vehicle.

All gauges are programmed into the instrument cluster and are therefore **visible only** in the DID.

- Current Gear Position (Automated Transmission)
- Outside Temperature
- Engine Oil Temperature
- Transmission Temperature
- Battery Voltage
- Front and Rear Axle Temperature
- Front and Rear Suspension Pressure
- Volvo Link Compass

14 Driver Information Display (DID)

1. Current Gear Position (Automated Transmission)

NOTE

When the vehicle is equipped with an automated transmission, the current transmission gear position is always displayed in the favorites display section.

The current gear position gauge is standard with automated transmissions.

- N = Neutral
- R = Reverse
- Forward Gear = 1–18 (varies with type of transmission)

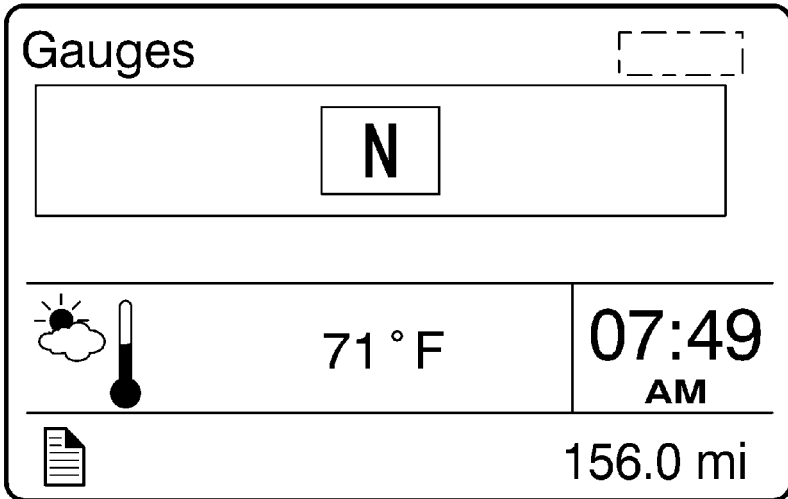

2. Outside Temperature

The outside temperature gauge is optional.

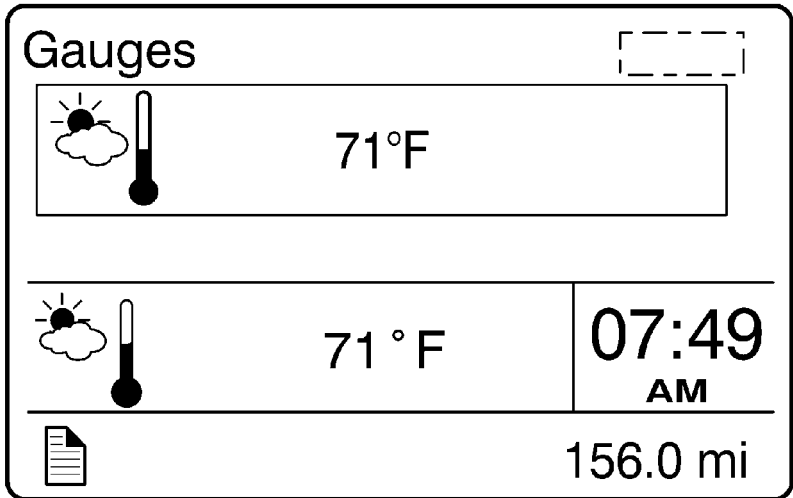

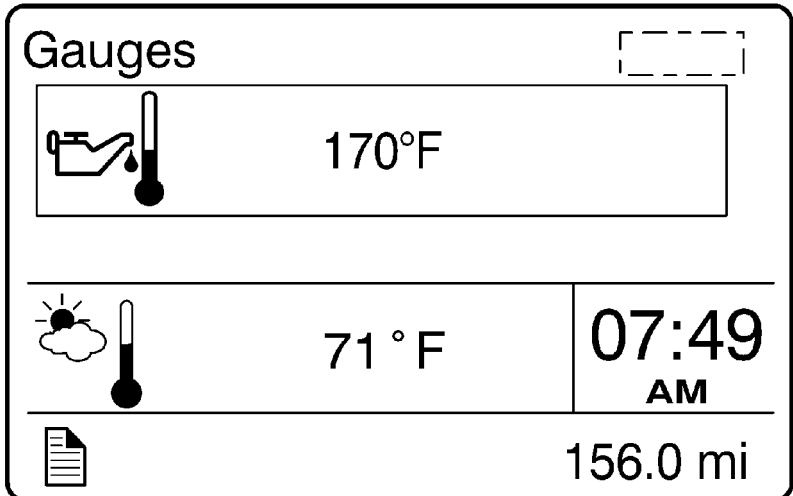

3. Engine Oil Temperature

The engine oil temperature is displayed as illustrated.



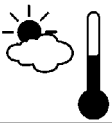

4. Transmission Oil Temperature

Gauges []

	< 113 °F	
	71 °F	07:49 AM
	156.0 mi	

5. Battery Voltage

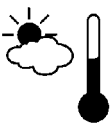
Gauges []

	13.1 V	
	71 °F	07:49 AM
	156.0 mi	

6. Front and Rear Axle Temperature

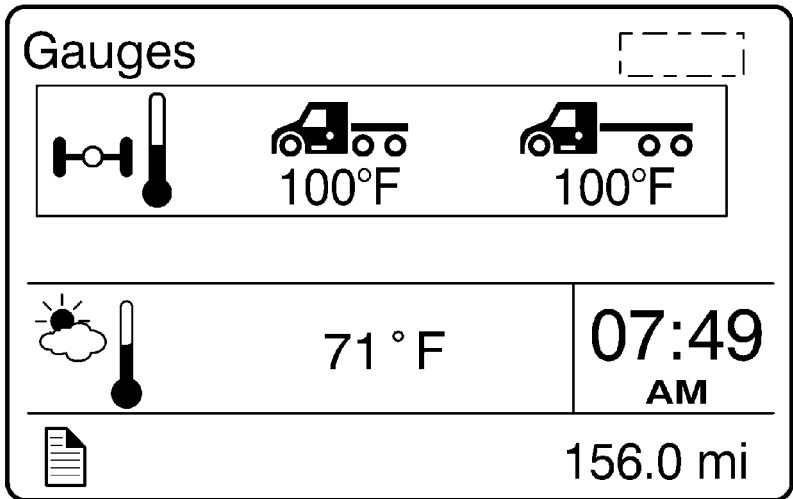

7. Front and Rear Suspension Pressure

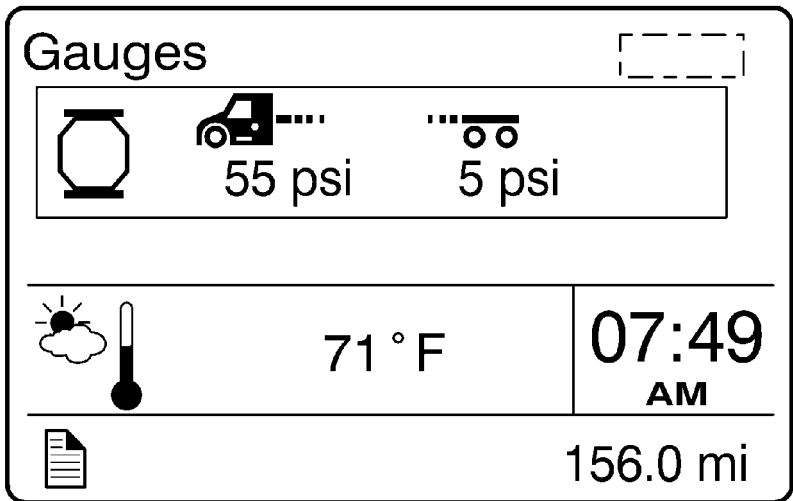

8. Volvo Link Compass

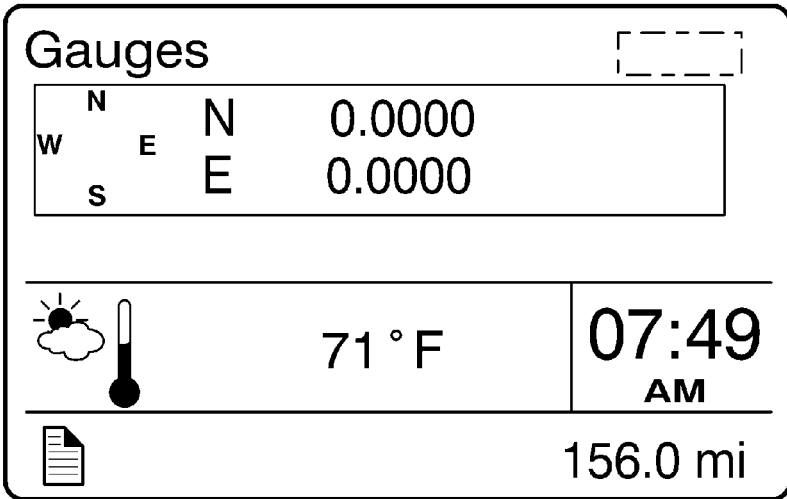

Fuel Data

The Fuel Data menu provides information on the fuel consumption of the vehicle in various situations. For example, how much fuel has been used, how much fuel is remaining, how much fuel is remaining before refueling the vehicle.

- Instantaneous Gallons Per Hour
- Trip Fuel Used
- Distance to Empty
- Fuel Economy
- Idle Percent
- Sweet Spot/Performance Bonus
- Sweet Spot Percentage
- Road Speed Limit

1. Instantaneous Gallons Per hour

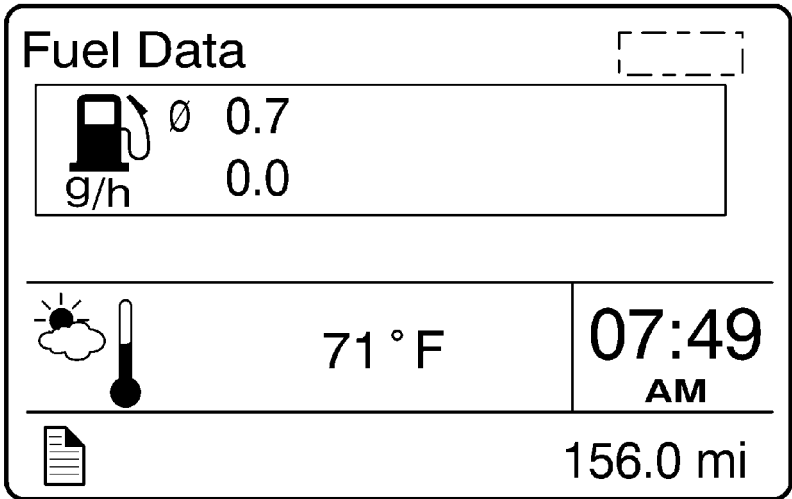

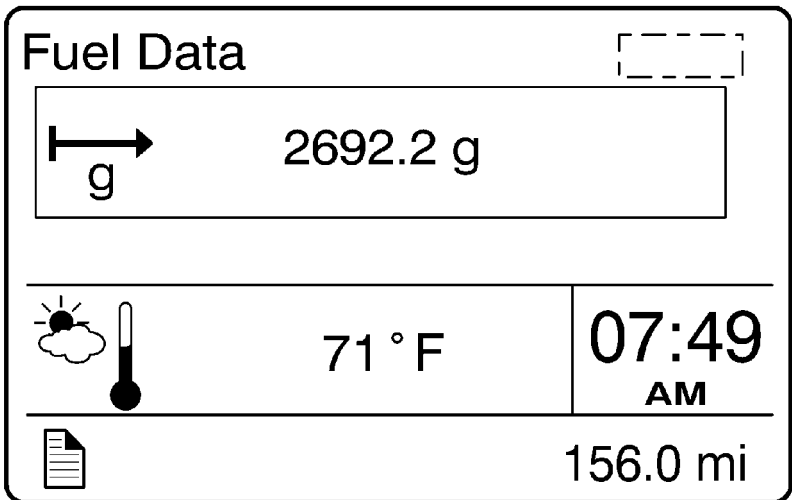

2. Trip Fuel Used



3. Distance to Empty

Fuel Data []



	 → Empty
1771 mi	13 g

	71 °F	07:49 AM
---	-------	-------------

	156.0 mi
---	----------

4. Fuel Economy

Fuel Data []

 mpg	 Fuel Economy 6.8 (7.2)
---	---

	71 °F	07:49 AM
---	-------	-------------

	156.0 mi
---	----------

5. Idle Percent

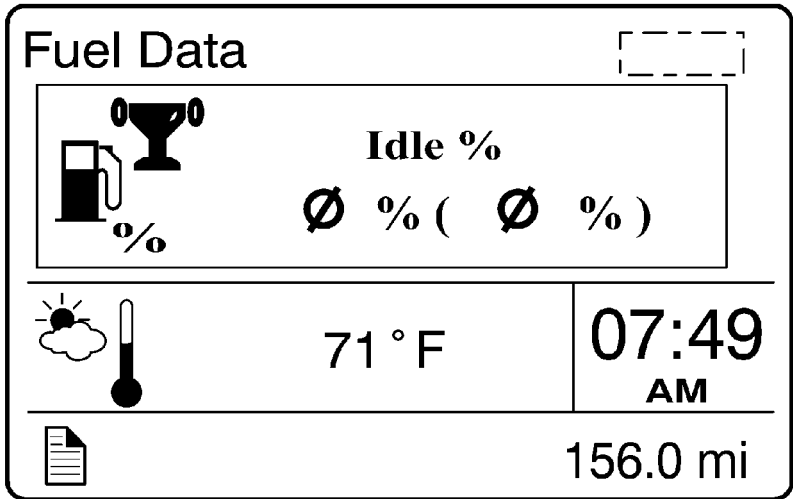

6. Sweet Spot/Performance Bonus

NOTE



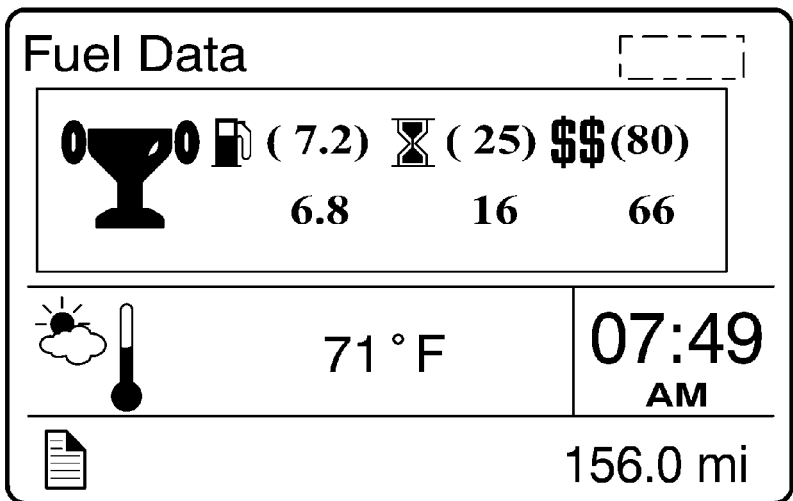

For information about sweet spot data, refer to Performance Bonus Guide in the vehicle operator's manual.







7. Sweet Spot Percentage

NOTE

For information about sweet spot data, refer to Performance Bonus Guide in the vehicle operator's manual.

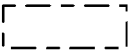
Fuel Data			
\$\$ %	Sweet Spot % 64%		
 	71 °F	07:49 AM	
	156.0 mi		

9. Road Speed Limit

Fuel Data			
 mph	Road Speed Limit --		
 	71 °F	07:49 AM	
	156.0 mi		

Time/Distance

The time and date can be set in the Time/Distance menu. The alarm clock can also be set from this menu. Following the alarm clock menu is the Distance to Destination selection, which allows the operator see the distance since the last reset. Average trip speed is also shown. By specifying the distance to your destination, the vehicle can calculate the estimated time of arrival (ETA).

- Time and Date
- Alarm Clock
- Distance to Destination
- Average Trip Speed
- Estimated Time of Arrival (ETA)

1. Time and Date

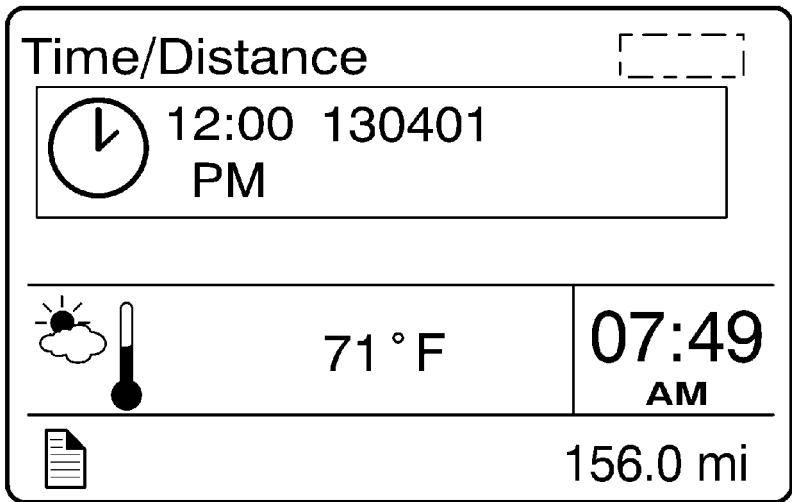

2. Alarm Clock

Time/Distance

	12:00 PM	OFF
---	-------------	-----

	71 °F	07:49 AM
---	-------	-------------

	156.0 mi
---	----------

3. Distance to Destination

Time/Distance

 mi	1 6.7	2 6.7
---	----------	----------

	71 °F	07:49 AM
---	-------	-------------

	156.0 mi
---	----------

4. Trip Average Speed

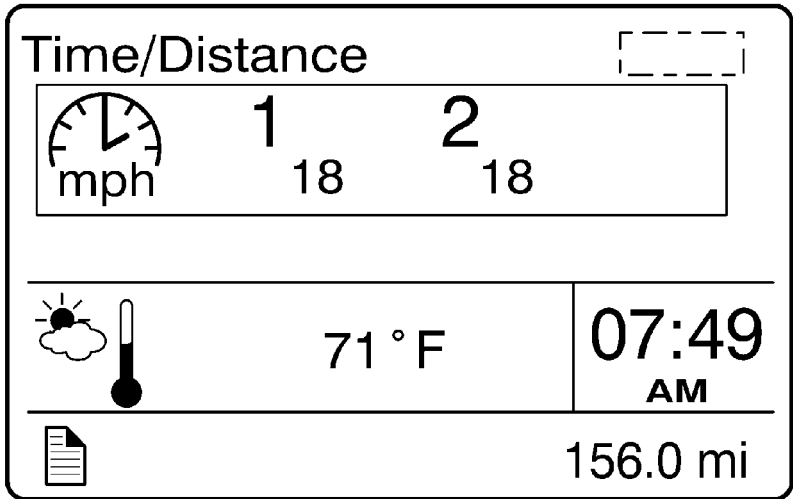

5. Estimated Time of Arrival (ETA)

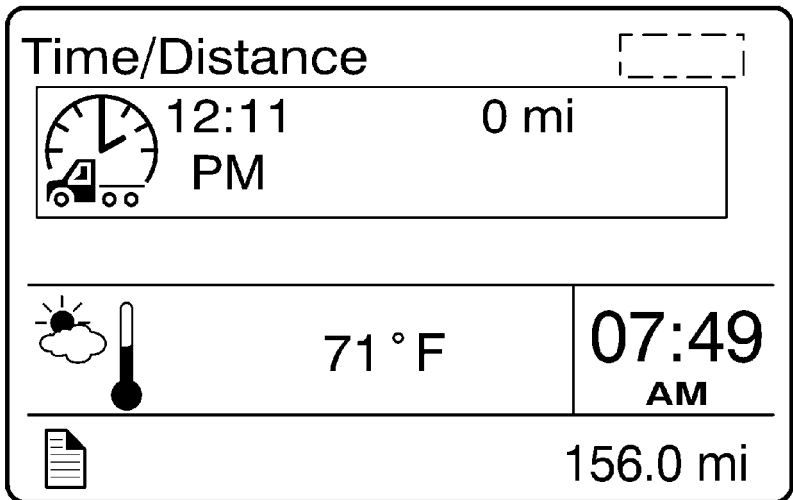

Aftertreatment



NOTE

For additional information about the aftertreatment system, refer to the vehicle operator's manual.

The Aftertreatment menu allows the operator to request a parked regeneration, check the status of the aftertreatment system, and cancel a regeneration.

Aftertreatment

Request Parked REGEN
ATS Status
Cancel REGEN

  71 °F

07:49
AM

 156.0 mi

Aftertreatment Menu

Aftertreatment Status

The aftertreatment status menus are used to help determine why a parked regeneration failed.

ATS Status

Clutch	OK	▲
Service Brake	OK	
PTO Status	OK	▼



71 °F

07:49
AM



156.0 mi

ATS Status

ACC Pedal	OK	▲
Neutral	OK	
Vehicle Speed Above	OK	▼



71 °F



07:49
AM



156.0 mi

ATS Status []



Park Brake	OK	▲
System Fault	OK	▼
System Timeout	OK	▼

  71 °F 07:49
AM

 156.0 mi

ATS Status []

Temporary Lockout	OK	▲
Permanent Lockout	OK	▼
Engine Temp	OK	▼

  71 °F 07:49
AM

 156.0 mi

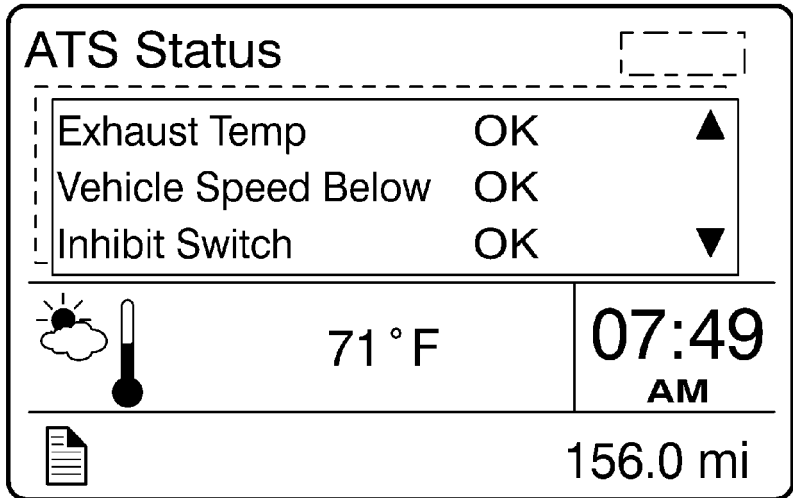

Volvo Link

For information about the Volvo Link System, refer to the Volvo Link System Operator's Manual.

Display

The operator can adjust the display in the Display menu. The entire display can be blacked out for night driving. The display brightness level is adjustable. The Favorite Display function allows the operator to select up to three different gauges to be displayed at the same time. Night/Day can be selected to provide a light or dark background.

- Black Panel
- Favorite Display
- Backlight
- Favorite Display Setting
- Night/Day

1. Black Panel

The screen and the entire display is completely dark, except the speedometer and tachometer. The black panel mode can be exited by pressing the Esc button.

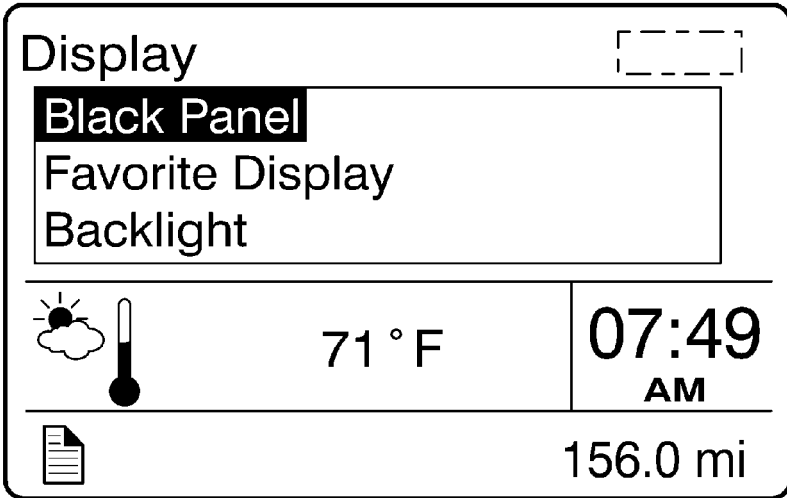

2. Favorite Display

NOTE

This section is for **viewing** your selection only. To choose your favorite selection go to Favorite Display Setting.

If Favorite Display is selected, the DID will always display the selected gauges.

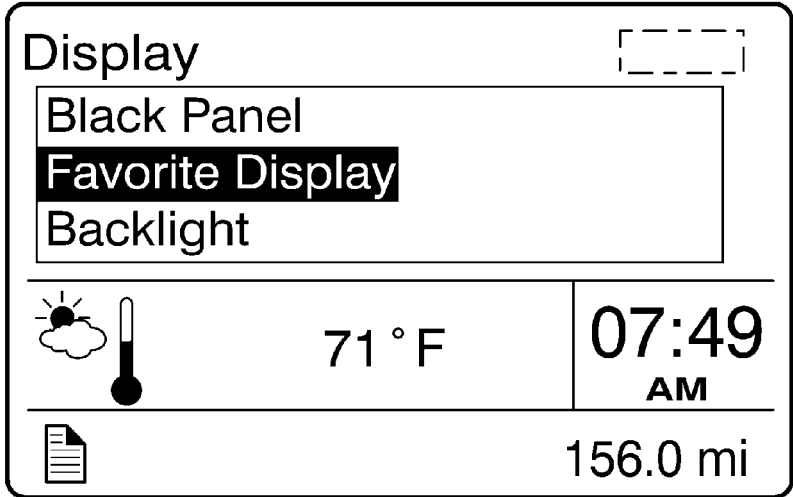

3. Backlight

To increase or decrease the backlight setting, press the up and down arrows on the stalk switch.

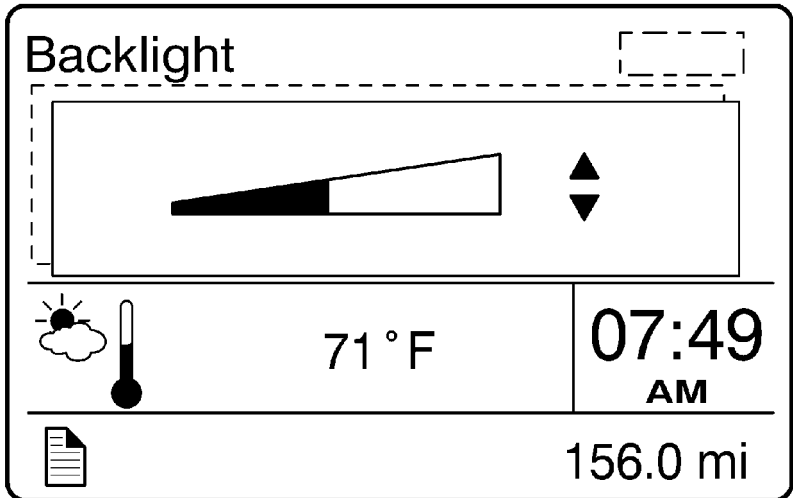

4. Favorite Display Setting

Select Favorite Display Setting to choose the gauges displayed on the DID.

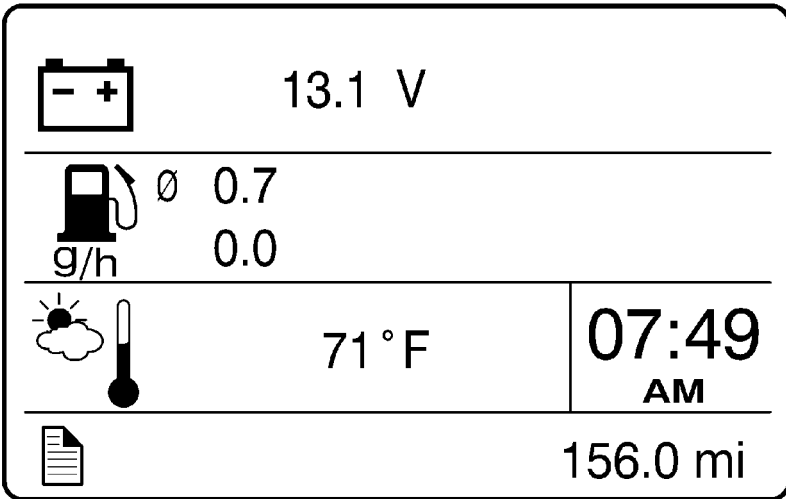

5. Night/Day

Use the Night/Day menu to choose a dark background with light text and images or a light background with dark text and images.

Vehicle Messages

Vehicle Messages appear in the DID depending on the number of faults the vehicle has at any given time.

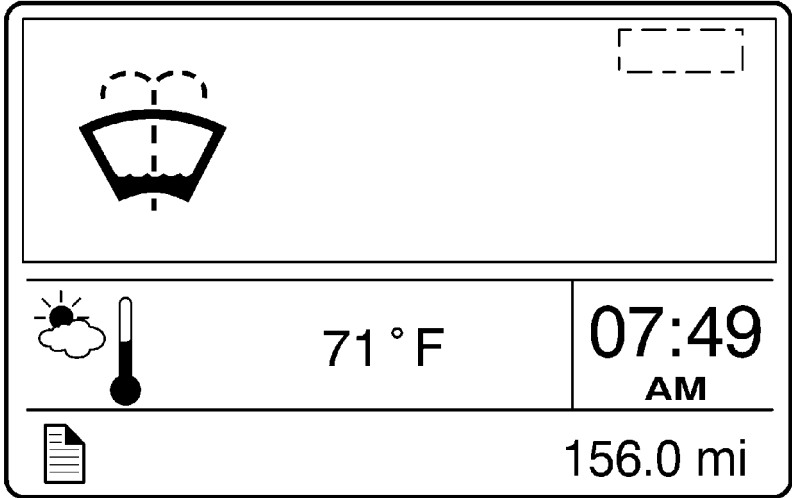

Windshield Washer Fluid Low Message

If there are no messages, the following screen is displayed.

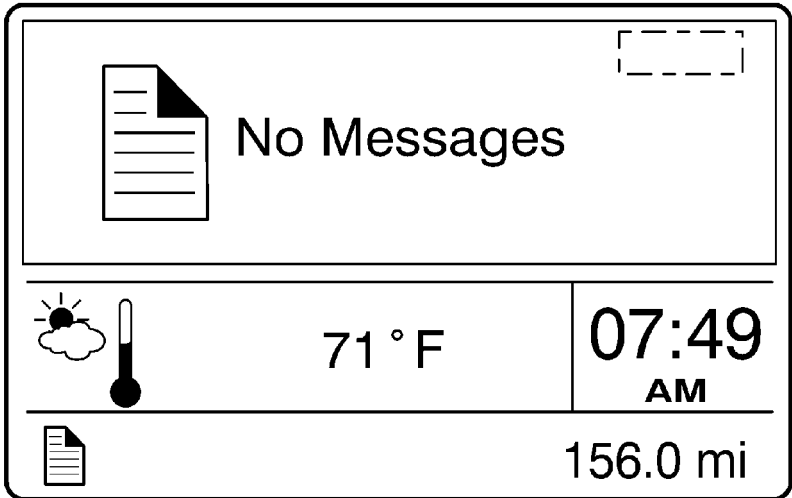

34 Driver Information Display (DID)

Reset

When the Reset menu is open, pressing and holding down the Enter button for more than 1 second resets the following functions:

- Instantaneous gallons per hour
- Trip fuel used
- Distance to empty

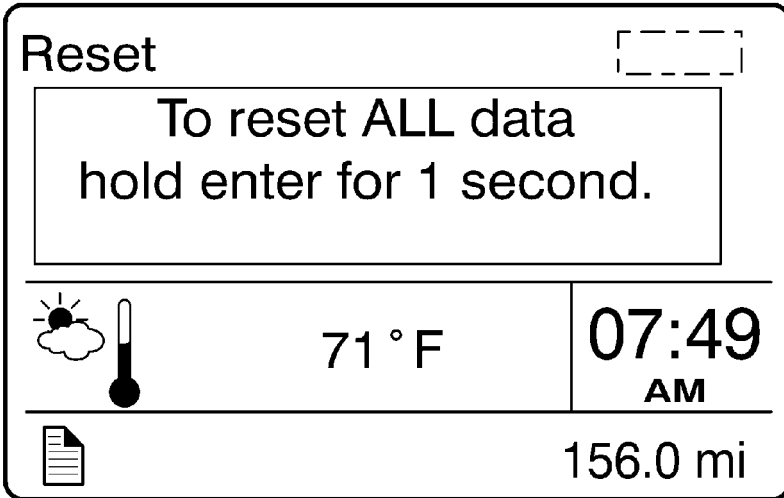

Non-Driving Menu

- Display Setting
 - Language
 - Units
 - Time/Date
 - Display Light
 - Change Password
- Vehicle Settings (Volvo engines only)
 - Fleet Limits
 - Fleet ID
 - Water in Fuel (if equipped)

- Diagnostics
 - Fault Diagnostics
 - Cluster Self Test
 - Part Number
- Vehicle Data (Volvo Engines Only)
 - Oil Level
- Data Log
 - Vehicle ID
 - Sweet Spot Data
 - Total Data
 - Trip Data
 - Reset Trip Data
- Password
 - Enter Password

Display Setting

The Display Setting menu is used to change languages and units. The password, time and date can also be changed. The backlight and contrast of the display screen can be adjusted.

- Language
- Units
- Time/Date
- Display/Adjust
- Change Password

1. Language

Display Settings

Language

English

Espanol

Francais

 156.0 mi

2. Units

- Distance
- Fuel Consumption
- Temperature

Display Settings

Units

Distance

km

mi

 156.0 mi

Distance

Display Settings 

Units

Fuel Consumption

- L/100km**
- Km/L
- mpg (IMP gallons)
- mpg (US gallons)

 156.0 mi

Fuel Consumption

Display Settings 

Units

Temperature

- °F**
- °C

 156.0 mi

Temperature

3. Time/Date

The Time/Date menu has two sub-menus:

- Clock Format
- Date Format

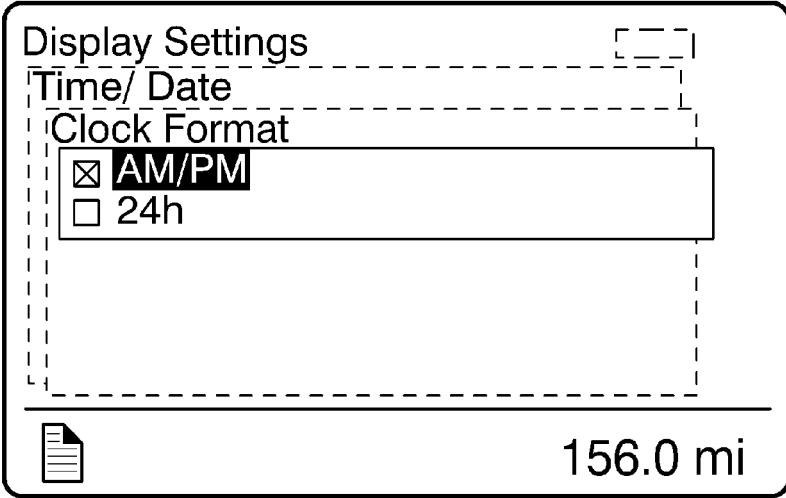

Clock Format

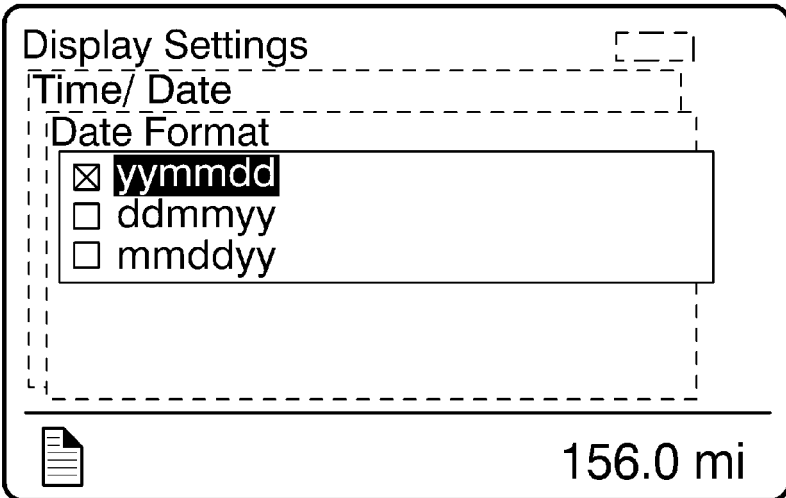

Date Format

4. Display Light

The Display Light menu has three sub-menus:

- Contrast
- Backlight
- Night/Day

Use the Night/Day menu to choose a dark background with light text and images or a light background with dark text and images

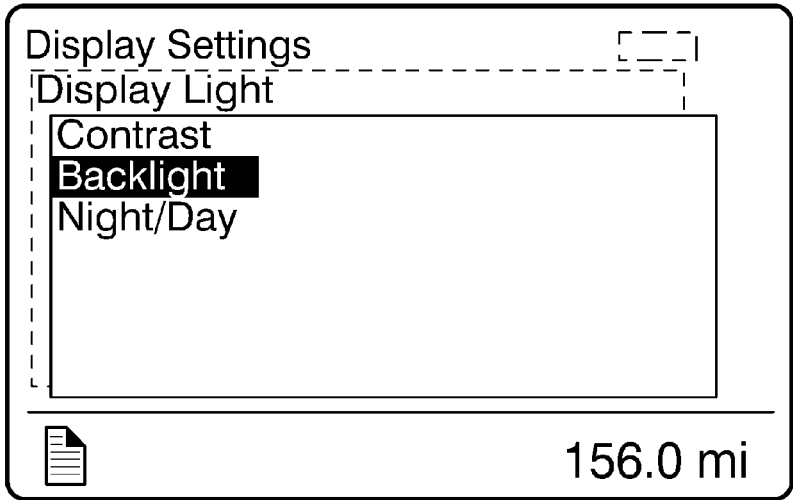

Display Light Menu

Display Settings

Display Light

Contrast

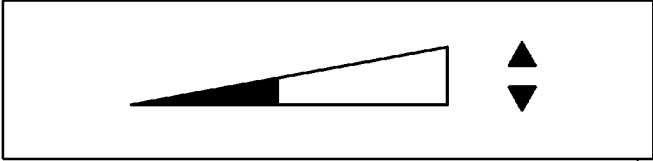

A horizontal slider control for contrast. The slider bar is a rectangle with a black wedge on the left side, tapering to a point. To the right of the slider bar are two vertical arrows, one pointing up and one pointing down, indicating the direction of adjustment.

156.0 mi

Contrast

Display Settings

Display Light

Backlight

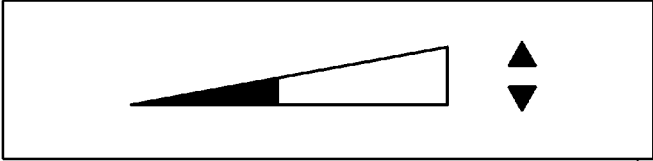

A horizontal slider control for backlight. The slider bar is a rectangle with a black wedge on the left side, tapering to a point. To the right of the slider bar are two vertical arrows, one pointing up and one pointing down, indicating the direction of adjustment.

156.0 mi

Backlight

5. Change Password

NOTE

This menu is only accessible if the correct password is entered. The default password from Volvo is 0000.

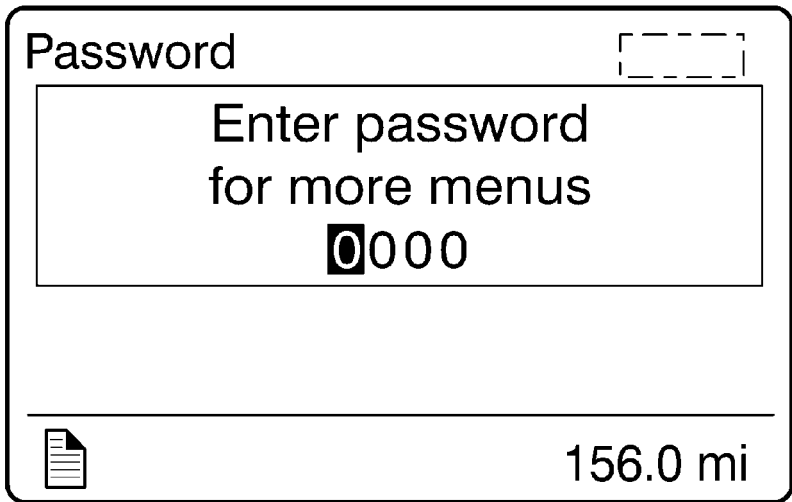

Vehicle Settings

The Vehicle Settings menu allows fleet owners to set targets for vehicle operation regarding maximum engine speed, maximum road speed, and fuel consumption.

1. Fleet Limits

The Fleet Limits menu has three sub-menus:

- RPM Limit
- Speed Limit
- Fuel Target

Vehicle Settings []

Fleet Limits

RPM Limit

Speed Limit

Fuel Target

 156.0 mi

Vehicle Settings []

Fleet Limits

RPM Limit

Present: 0000 revs

Set new value: **0**000 revs

 156.0 mi

RPM Limit

Vehicle Settings []

Fleet Limits

Speed Limit

Present:	0 . 0 mph
Set new value:	0 00 . 0 mph

 156.0 mi

Speed Limit

Vehicle Settings []

Fleet Limits

Fuel target

Present:	23 . 5 mpg
Set new value:	2 3 . 5 mpg

 156.0 mi

Fuel Target

2. Fleet ID**NOTE**

This menu can only be accessed if the correct password has been entered.

The owner can enter the Fleet ID of the vehicle in this menu if required. Data registered in the engine control unit is then registered for this ID. Enter the new Fleet ID using the up and down arrows. Enter one number at a time followed by pressing the Enter button. 13 characters must be entered, blank characters are entered in unused positions. The ignition key must be turned off and back on to update the fleet ID.

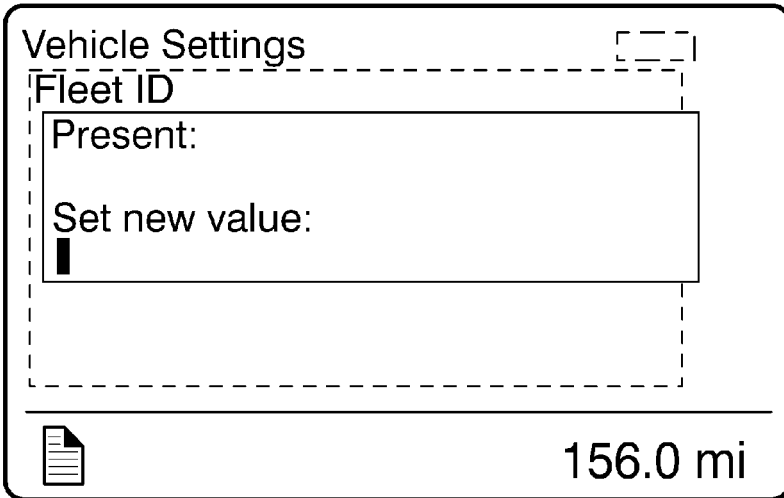

3. Drain Water in Fuel (if equipped)

Press the Enter button to request drain the water in the fuel.

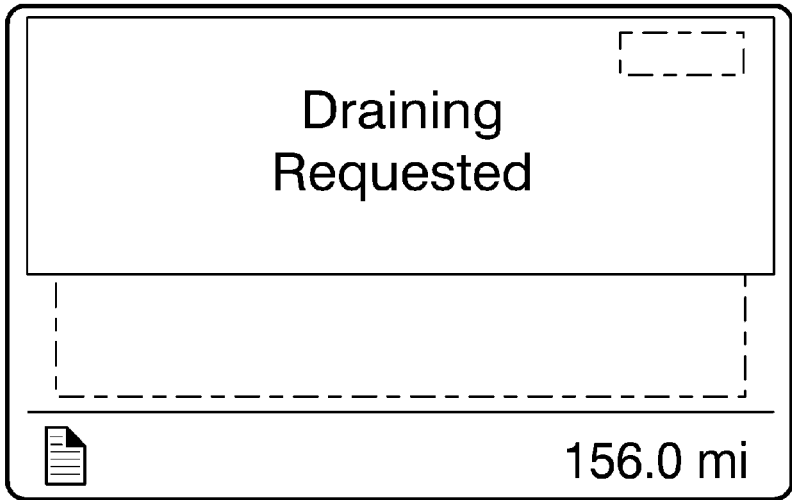
**Diagnostics**

The Diagnostics menu enables fault tracing on the control units in the vehicle to check for faults. Instrument tests are available to check the telltales, gauges, display and speaker. The part number of a control unit can be identified in the part number menu.

1. Fault Diagnostics

A list of the control units on the vehicle is displayed in the Fault Diagnostics menu.

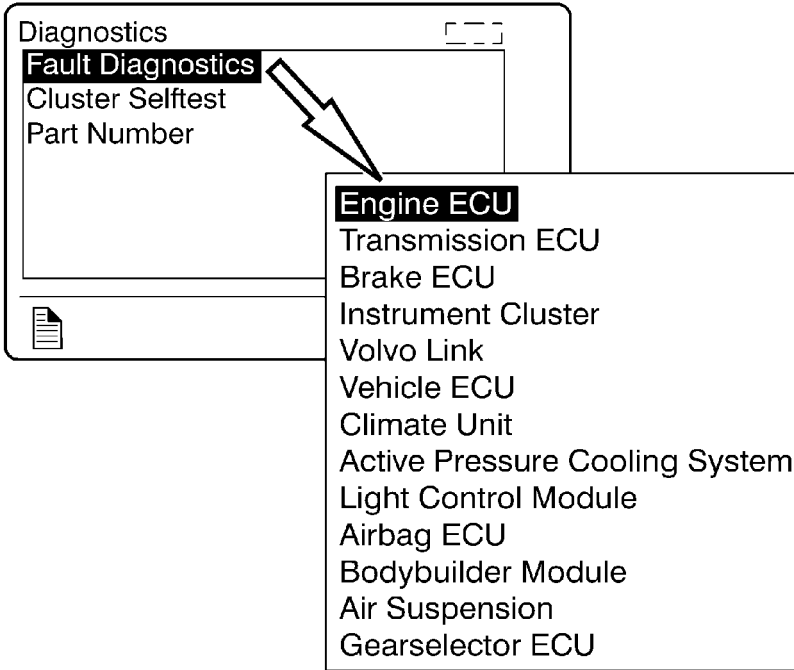

2. Cluster Self Test

There are four sub-menus available:

- Telltales test
- Gauge test
- Display test
- Speaker test

The following table describes the tests. To cancel a test, press the Esc button.

Telltale Test	Telltale illuminate for approximately five seconds.
Gauge Test	The indicators move forwards and backwards between the end positions. They do not show any particular value. This is just a check to confirm that the indicators move, and to make sure the operators are working.
Display Test	The entire display lights up until the Esc button is pressed.
Speaker Test	The sound is activated and at the same time, the name of the selected sound is shown in the DID screen.

3. Part Number

A list of the control units on the vehicle is displayed in the Part Number menu.

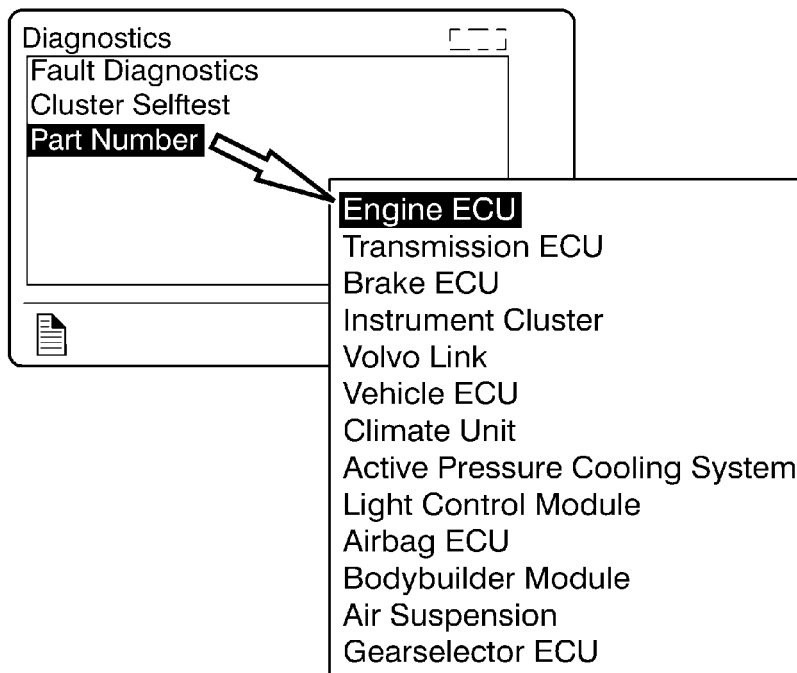

Diagnostics 

Part Number

Data Transfer
In Progress
Please Wait

 156.0 mi

Diagnostics 

Part Number

Airbag ECU

Hardware number:
VOLVO*20452786P01
00000409

Software number:
20452787P01
20452780 P0120452783 P01

 156.0 mi

Diagnostics

Part Number

Hardware Number:
No data

Software Number:
No data

 156.0 mi

Communication Error

Vehicle Data

The engine oil level can be checked in the Vehicle Data menu.

1. Oil Level (*Volvo engines only*)

NOTE

For information about engine oil, refer to the Operator's Manual Vehicle Maintenance.

The vehicle is equipped with an electronic oil level sensor. The bar marked MIN and MAX shows the engine oil level. The number in the middle indicates the difference between the MIN and MAX level.

Vehicle Data

Oil Level

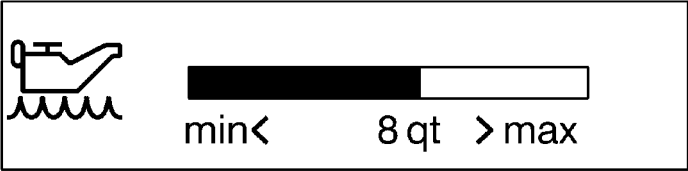

min< 8 qt >max



156.0 mi

Datalog

1. Vehicle ID

Datalog

Vehicle ID

Fleet ID:

0000000

Chassis ID:

0000000



156.0 mi

Datalog 

Vehicle ID

Operation Failed.

 156.0 mi

Communication Error

2. Sweet Spot Data

NOTE

For information about sweet spot data, refer to Performance Bonus Guide in the vehicle operator's manual.

Datalog 

Sweet Spot Data

Sweet Spot % Fuel:

Trip Data 64%

Total Data 64%

 156.0 mi

3. Total Data

Totals indicate the accumulated engine values that have been logged during the lifetime of the engine ECU. Six different totals are stored.

Datalog 

Total Data

Total distance:
136.3 mi

Total fuel used:
24.2 g

 156.0 mi

Datalog 

Total Data

Total engine hours:
7.4 hours

Total idle time:
2.7 hours

 156.0 mi

Datalog	
Total Data	
Total PTO hours:	0.0 hours
Total engine revolutions:	421000 revs
	156.0 mi

4. Trip Data

NOTE

Some menus are not available with the Cummins ISX engine.

There are 14 different trip data values stored.

NOTE

The trip data must be reset before each measurement, see “5. Reset Trip Data” on page 57.

Datalog 

Trip Data

Trip distance:	136.3 mi
Trip fuel avg:	5.6 mpg

 156.0 mi

Datalog 

Trip Data

Trip fuel acc:	24.1 g
Trip cruise:	0.6 hours

 156.0 mi

Datalog 

Trip Data

Trip
uneconomy rev's:
0.3 hours

Trip overrev's:
7.4 hours

 156.0 mi

Datalog 

Trip Data

Trip fuel
uneconomy rev's:
2.7 g

Trip average speed:
18.5 mph

 156.0 mi

Datalog

Trip Data

Trip overspeed:

3.9 hours

Trip engine hours:

7.4 hours



156.0 mi

Datalog

Trip Data

Trip idle time:

2.7 hours

Trip idle fuel:

4.5 g



156.0 mi

Datalog 

Trip Data

Trip PTO hours:
0.0 hours

Trip PTO fuel:
0.0 g

 156.0 mi

5. Reset Trip Data

NOTE

This menu can only be accessed if the correct password has been entered.

Datalog 

Reset Trip Data

To reset
hold enter for 1 second.

 156.0 mi

Datalog []

Reset Trip Data

Data Transfer
In Progress
Please Wait

 156.0 mi

Datalog []

Reset Trip Data

Operation
Complete.

 156.0 mi

Successful Reset

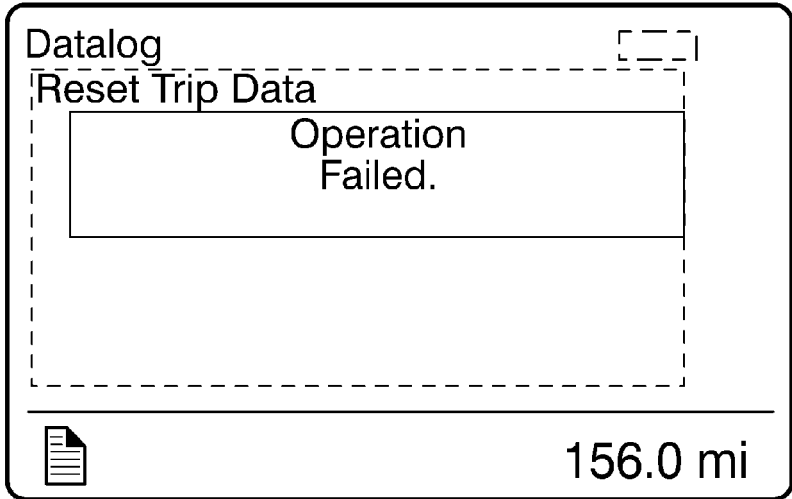

Unsuccessful Reset

Password

Certain functions are password-protected and there are a number of passwords for the display. It is also possible to disable the password protection for functions, which is useful when the owner is the operator. Contact your local Volvo dealer to set this function.

1. Password

NOTE

This password must be changed to prevent unauthorized access to the menus.

These passwords give the user access to all password-protected functions. See “5. Change Password” on page 41 to change the password.

The following menus are password-protected and marked with a key symbol in the menus:

- Fleet Limits
- Fleet ID
- Reset (applies to a number of functions)

When the ignition key has been in the stop position for more than 60 seconds or the batteries have been disconnected, the password must be entered again in order to access all the functions.

No functions should be password-protected:

To make all menus available without password you must go to Password and press the Enter button.

You can also go to a password-protected menu and press the Enter button. A password entry box is displayed.

1. Select the Password menu.
2. The password consists of a four-digit number, 0000–9999, that is scrolled forward using the up and down arrows on the control lever, one number at a time, followed by pressing the Enter button. The display shows the following:

Press the Enter button when the correct password has been entered.

NOTE

If the ignition key has been in the stop position for more than 60 seconds or the batteries have been disconnected, the password must be entered again in order to access all the functions.

3. If an incorrect password is entered, the user is returned to point 2. Re-enter the password using the up and down arrows, followed by the Enter button on the control stalk as in point 2.

Display Settings []
Vehicle Settings
Diagnostics
Vehicle Data
Datalog
Password

 156.0 mi









Password []









Enter password
for more menus
0000









 156.0 mi







DISPLAY SYMBOLS



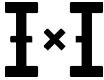





Alarm, Check and Information Symbols









Symbol	Meaning
	Coolant temperature
	Coolant level
	Engine oil pressure
	Engine Oil level
	Engine oil temperature
	High engine oil temperature
	Fault in preheating
	Engine temperature too low for engine brake (VEB)



Symbol	Meaning
	Air filter restriction
	Engine idle shut down
	Transmission oil temperature
	High transmission oil temperature
	Transmission malfunction
	Low brake pressure or ABS
	Air dump
	Air suspension pressure
	Air suspension pressure warning

Symbol	Meaning
	Wheel spin
	Anti-spin temporarily disengaged
	5th wheel unlocked
	Stop
	Voltage meter
	Voltage warning
	SRS
	Low level washer fluid
	Fault in main beam

Symbol	Meaning
	Interaxle lock
	Differential lock
	Fault in brake light
	Fault in blinkers
	Caution, freezing conditions
	Fuel level
	Outside temperature
	Air application



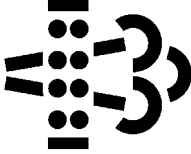

Symbol	Meaning
	Parking Brake engaged
	Axle Temperature
	Engine speed
	Intake manifold pressure
	Instantaneous/average fuel economy (liters/100km)
	Instantaneous/average fuel economy (km/liter)
	Instantaneous/average fuel economy (mpg)
	Instantaneous/average fuel economy (liters/hour)
	Leg fuel (liter)







Symbol	Meaning
	Leg fuel (gallon)
	Trip data (km)
	Trip data (miles)
	Average speed (km/h)
	Average speed (mph)
	Estimated time of arrival
	Estimated time of arrival
	Safety Belts Reminder
	Performance Bonus Guide

Symbol	Meaning
 A black icon of a fuel pump nozzle with three water droplets falling from it, indicating water contamination in the fuel system.	Water in fuel
 A black icon showing a stylized engine or exhaust component with several dots and curved lines, representing the process of aftertreatment regeneration.	Aftertreatment Regeneration
 A black icon showing a stylized exhaust pipe with a thermometer-like gauge and curved lines, indicating high exhaust system temperature.	High Exhaust System Temperature

STATUS SYMBOLS

Status symbols are displayed at the bottom of the Mid Level and High Level instrument cluster DID screens.

Symbol	Meaning
	Preheating active or preheating fault
	Alarm clock activated
	Message active
MI	Odometer, miles
KM	Odometer, kilometers
PTO	Power take-off active
CC	Cruise Control active
(1)	Engine brake position 1
(2)	Engine brake position 2
(6)	Engine brake position 6
	Axle suspension pressure, front

Symbol	Meaning
	Axle suspension pressure, rear
	Distance to empty
	ABS malfunction trailer
	ABS malfunction tractor
	Water in fuel priming
	Water in fuel draining

Other Symbols

There are various other symbols for the other menus which are not explained here. Refer to the sections on the different menus for explanations of those symbols.

MESSAGES

General

There are three types of messages:

- Stop
- Warning
- Information

Stop, warning, and information messages are displayed automatically with their associated symbols. Above the display are three lamps (for stop warning, or information messages) used to draw the attention of the operator whenever necessary. If the engine is running when a stop message comes on, a buzzer is also activated.

More than one message can be active at the same time. A displayed message can be replaced by a new message provided the new message has a higher priority. i.e.: The displayed message is the highest priority.

Only fault codes that have a direct impact on vehicle operation are displayed. All fault codes are stored in the appropriate ECU for access by service technicians.

Stop Message



Failure to stop and take necessary action when the STOP message light is on can result in automatic engine shutdown and loss of power steering assist. This can result in vehicle accident, personal injury or death.

In the event of a serious fault, the red STOP light comes on; the buzzer will also activate if the engine is on. An illuminated STOP message light signifies a serious problem has been detected, and the operator must respond immediately to the problem.



This lamp ON means the vehicle must be safely pulled off the road and stopped. In some instances, the engine must be switched off immediately.

In some cases preventive action may be taken by the engine ECU to protect the engine.

Example 1: if oil pressure or coolant level drops too low, the engine is forced to low idle and when the vehicle speed is zero, the engine shuts down.

Example 2: with excessive coolant temperature, the engine will gradually reduce power output to 50%. This telltale always activates the buzzer.

The engine may be restarted after the key is turned off and then back on. However, it will only operate for 30 seconds unless the problem is resolved.

The engine could be forced to low idle within 30 seconds from when the light comes on. Pull off the road as soon as possible without creating a safety hazard.

 **CAUTION**

If an engine problem is allowed to persist, serious damage to the engine may occur. Always repair the cause of the problem before operating the vehicle again.

See “Stop, Check, Info Symbols and Associated Icons” on page 74 for other telltales that trigger the STOP message light.

Warning Message

 **DANGER**

The CHECK warning message lights up when there is a specified fault the operator should be aware of. Air pressure is low and remaining air volume may not be sufficient for repeated braking. The emergency brakes may engage, causing a wheel lockup, loss of vehicle control. This can cause the vehicle to become a hazard to vehicles behind it.

Bring the vehicle to a controlled stop. Failure to follow these precautions can result in loss of braking control, serious personal injury, vehicle accident or death.

NOTE

This lamp ON means that there is a specified fault that must be checked at the next stop.

CHECK

If there is an electrical or mechanical problem with the sensor, the **CHECK** warning light comes on and a default message appears in the DID.

See “Stop, Check, Info Symbols and Associated Icons” on page 74 for other telltales that trigger the **CHECK** warning light.

Information Message**NOTE**

This indicator light ON means there is a new information message.



















The **INFO** indicator light comes on when there is a new information message or an abnormal status is detected by the electronic control unit. A telltale, text or both are shown in the DID in addition to the **INFO** light. For certain telltales, a reference value is also shown.









NOTE

Make sure the indicated fault is checked at the next stop once the **INFO** indicator come on.

See “Stop, Check, Info Symbols and Associated Icons” on page 74 for other telltales that trigger the **INFO** indicator.

Stop, Check, Info Symbols and Associated Icons

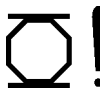
Symbols and Associated Icons		
		
Icons Displayed		
		
		
		
		
		
		

Acknowledging Messages

A fault message is acknowledged by pressing the Esc button after which the display returns to the same status that existed before the fault occurred. All messages can be acknowledged. Acknowledged but inactive messages are displayed again when the ignition key is turned to the START position or they can be read in the menu.

Information or Warning Messages: Information and warning messages can be acknowledged using the “Esc” button. This warning stays acknowledged until the next time the ignition key is turned to the START position.

Exceptions: The message can be displayed again if the fault is corrected and then becomes active again.

Example: If the transmission fluid temperature is too high, a message will be activated automatically. The operator acknowledges this message using the Esc button. If the temperature then drops to a normal level temporarily and then increases again to an excessive level, the warning will activate again.

Stop Message: The buzzer and a STOP message can be acknowledged using the Esc button, but may become active again 10 seconds after the last acknowledgment. The STOP symbol will be illuminated the whole time.

Examples of Fault Symbols and Text

Factory-Installed Equipment When Stationary

The stop, warning, or info symbol comes on and the information message is shown on the display (for more information on the fault, see “1. Fault Diagnostics” on page 46). A warning tone will be heard if the engine is running when a stop message is activated. The message contains information about the location of the fault where the fault has occurred:

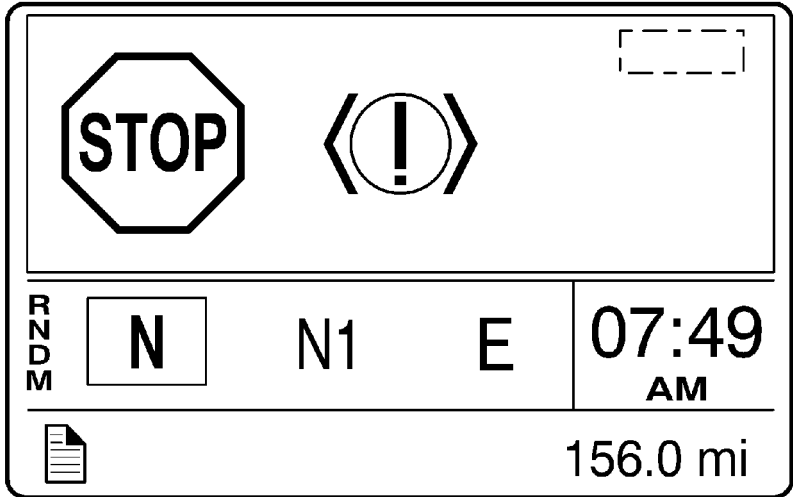

Non-Factory-Installed Equipment

If a coach builder or customer has retrofitted equipment that is connected to the data link, the following symbols may be displayed:

MID (Message Identifier) = control unit

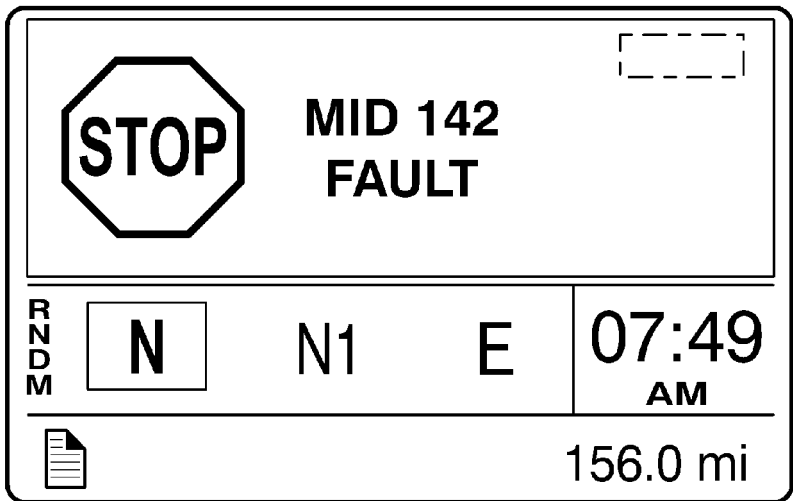

Examples of Symbol and Value

Information, warning or stop symbol comes on and another symbol and value is displayed. Example of warning message:

Warning, Freezing Conditions

The Freezing conditions message is activated when the outside temperature drops below 35 °F or increases from a lower temperature to 28 °F. Press the Esc button to acknowledge the warning. The warning is cancelled when the temperature drops below 26 °F or rises to 37 °F.

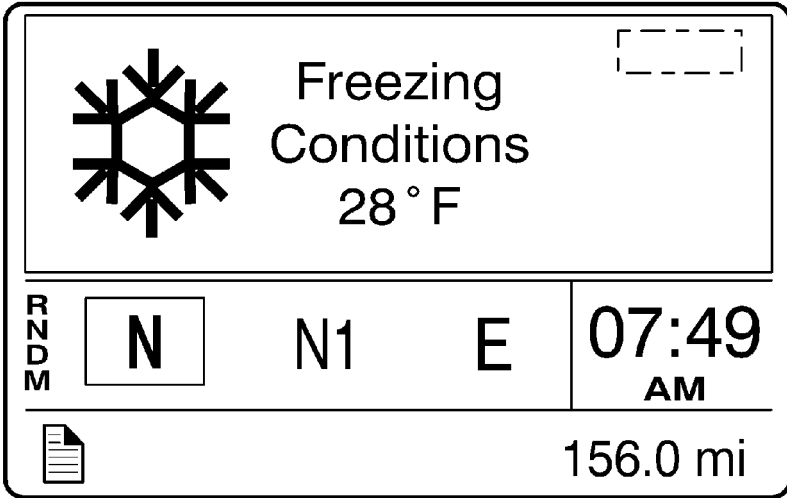

A

Acknowledging Messages	76
Aftertreatment	8, 26
Alarm Clock	24

B

Backlight	7, 31, 40
Battery Voltage	16
Black Panel	30

C

Change Password	41
Changing Settings	5
Clock format	38
Cluster Self Test	46
Contrast	7, 39
Current Gear Position	14

D

Datalog	50
Date Format	38
Diagnostics	45
DID, Basic Level	5
DID, Mid and High Level	10
Display	29
Display Light	39
Display Setting	35
Distance	9, 36
Distance to Destination	7, 24
Distance to Empty	20
Driver Information Display, Basic Level	5
Driver Information Display, Mid and High Level	10
Driving Menus	12

E

Engine Oil Temperature	15
Estimated Time of Arrival (ETA)	25

F

Fault Diagnostics	46
Favorite Display	30
Favorite Display Setting	32
Fleet ID	44
Fleet Limits	41
Front and Rear Axle Temperature	17
Fuel Consumption	36
Fuel Economy	20

G

Gear Position Current	14
---------------------------------	----

I

Idle Percent	21
Information Messages	71
Instantaneous Gallons Per Hour	19
Instrument Cluster, Basic Level	5
Instrument Cluster, Mid and High Level	10

L

Language	9, 36
--------------------	-------

M

Messages	71
--------------------	----

N

Night/Day	32, 40
---------------------	--------

O

Oil Level	49
Outside Temperature	7, 15

P

Part Number	47
Password	59

R

Reset (Driving Mode DID)	34
Reset Trip Data	57
Road Speed Limit	22

S

Selecting a Menu	4
Stalk Switch Control Lever	3
Stop Messages	71
Suspension Pressure	17
Sweet Spot Data	51
Sweet Spot Percentage	22
Sweet Spot/Performance Bonus	21

T

Temperature	9, 37
Time and Date	23
Time/Date	7
Time/Distance	23
Total data	52
Transmission Oil Temperature	16
Trip Average Speed	25
Trip Data	53
Trip Fuel Used	19

U

Units	36
-----------------	----

V

Vehicle ID	50
Vehicle Messages	32
Vehicle Settings	41
Volvo Link	29
Volvo Link Compass	18

W

Warning Messages	71
Warning, Freezing Conditions	78

1-800-52-VOLVO

Volvo Action Service (VAS) Support Center

- If you need assistance on the road or if you need service repairs, contact the VAS support center. VAS is available 24 hours per day, 7 days per week at **1-800-528-6586**.
- Please report the specific nature of the service problem to the Volvo Customer Support Specialist, who will answer your questions and arrange for the assistance you need.

Truck Model & Serial

Engine Model & Serial

Transmission Model & Serial

Rear Axle Model & Serial

Your Truck Was Delivered By:

VOLVO

Volvo Trucks North America

P.O. Box 26115 Greensboro, NC 27402-6115

Volvo Trucks Canada, Ltd.

5600A Cancross Court, Mississauga, Ontario L5R 3E9

<http://www.volvotrucks.volvo.com>